

Feed-through header - PTSM 0,5/ 6-HH-2,5-THR R32 - 1778667

Please be informed that the data shown in this PDF Document is generated from our Online Catalog. Please find the complete data in the user's documentation. Our General Terms of Use for Downloads are valid (<http://phoenixcontact.com/download>)



PCB headers, nominal current: 6 A, number of positions: 6, pitch: 2.5 mm, color: black, contact surface: Tin, mounting: THR soldering

The figure shows the 3-pos. version

Your advantages

- ✓ Designed for integration into the SMT soldering process
- ✓ Supplied in tape-on-reel packing according to IEC 60286-3 for automated mounting

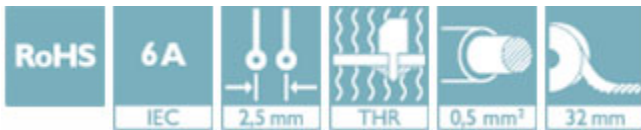

Key Commercial Data

Packing unit	1 pc
Minimum order quantity	500 pc
GTIN	
GTIN	4046356529846
Weight per Piece (excluding packing)	1.760 g
Custom tariff number	85366930
Country of origin	India

Technical data

Dimensions

Length [l]	7.5 mm
Width	16.7 mm
Pitch	2.5 mm
Dimension a	12.5 mm
Width [w]	16.7 mm
Height [h]	7 mm

Feed-through header - PTSM 0,5/ 6-HH-2,5-THR R32 - 1778667

Technical data

Dimensions

Height	5 mm
Length of the solder pin	2.1 mm
Pin dimensions	0.6 x 0.6 mm
Pin spacing	2.50 mm
Length	7.5 mm

General

Range of articles	PTSM 0,5/..-HH-THR
Insulating material group	IIIa
Rated surge voltage (III/3)	2.5 kV
Rated surge voltage (III/2)	2.5 kV
Rated surge voltage (II/2)	2.5 kV
Rated voltage (III/3)	50 V
Rated voltage (III/2)	160 V
Rated voltage (II/2)	160 V
Connection in acc. with standard	EN-VDE
Nominal current I_N	6 A
Maximum load current	6 A
Insulating material	LCP
Flammability rating according to UL 94	V0
Color	black
Number of positions	6

Standards and Regulations

Connection in acc. with standard	EN-VDE
	UL
Flammability rating according to UL 94	V0

Environmental Product Compliance

China RoHS	Environmentally friendly use period: unlimited = EFUP-e
	No hazardous substances above threshold values

Drawings

Feed-through header - PTSM 0,5/ 6-HH-2,5-THR R32 - 1778667

Drilling diagram

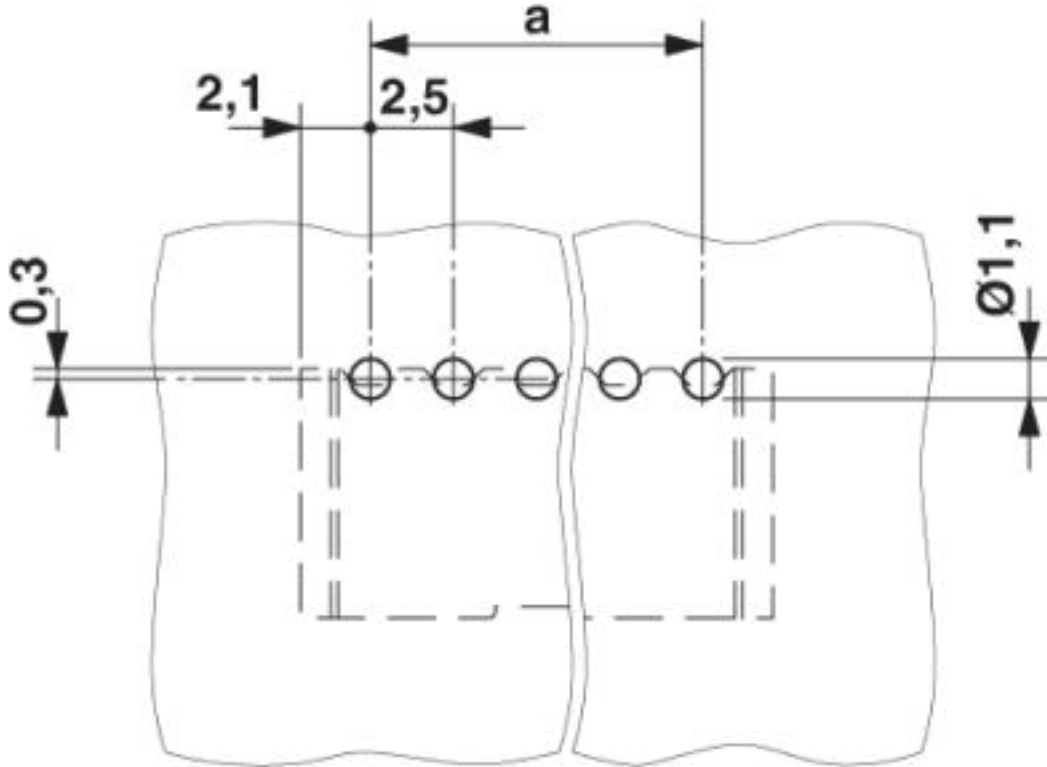

Feed-through header - PTSM 0,5/ 6-HH-2,5-THR R32 - 1778667

Diagram

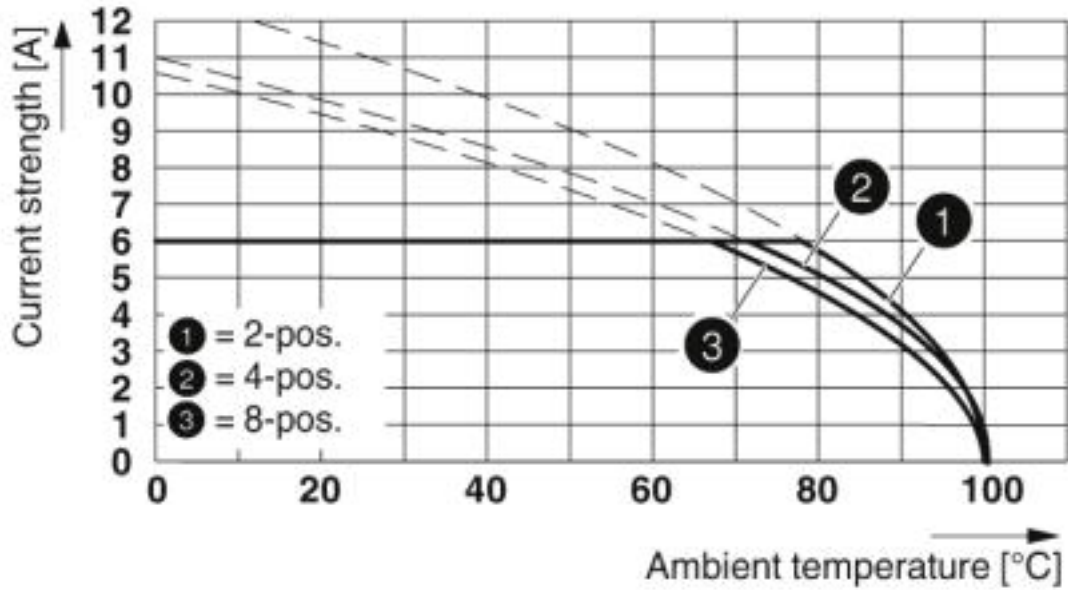

Derating curve for: PTSM 0,5/...P-2,5 with PTSM 0,5/...HH-2,5-THR R..

Diagram

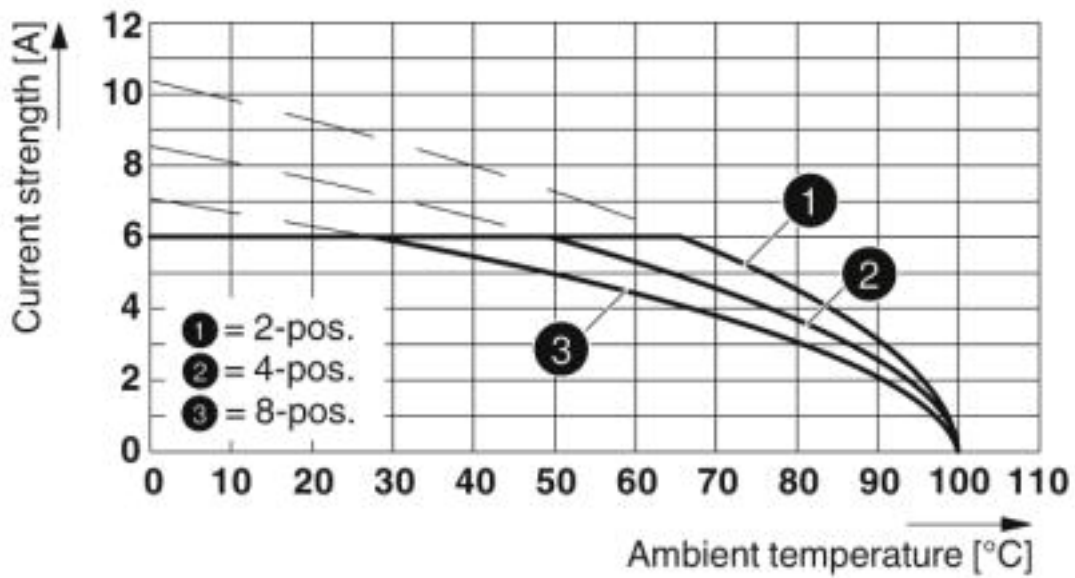

Type: PTSM 0,5/...HH-1-2,5-THR R... with PTSM 0,5/...HH-2,5-THR R...

Feed-through header - PTSM 0,5/ 6-HH-2,5-THR R32 - 1778667

Diagram

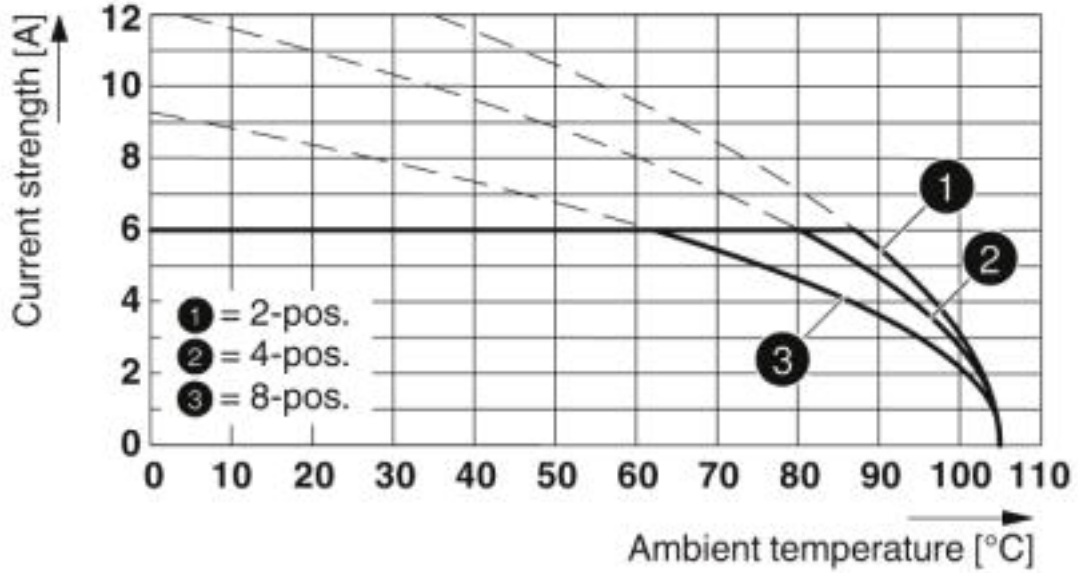

Type: PTCM 0,5/...-PL-2,5 WH with PTSM 0,5/...-HH-2,5-THR WH R...

Dimensional drawing

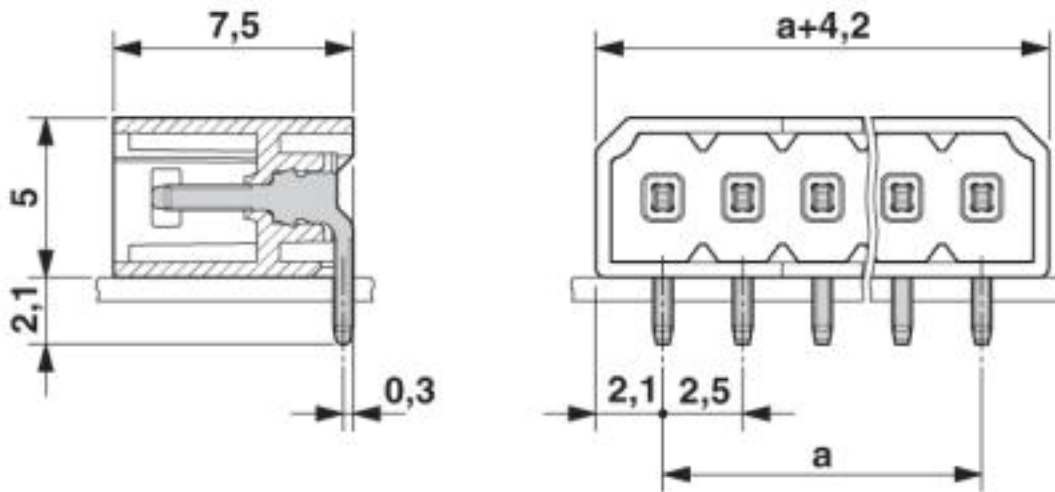

Feed-through header - PTSM 0,5/ 6-HH-2,5-THR R32 - 1778667

Dimensional drawing

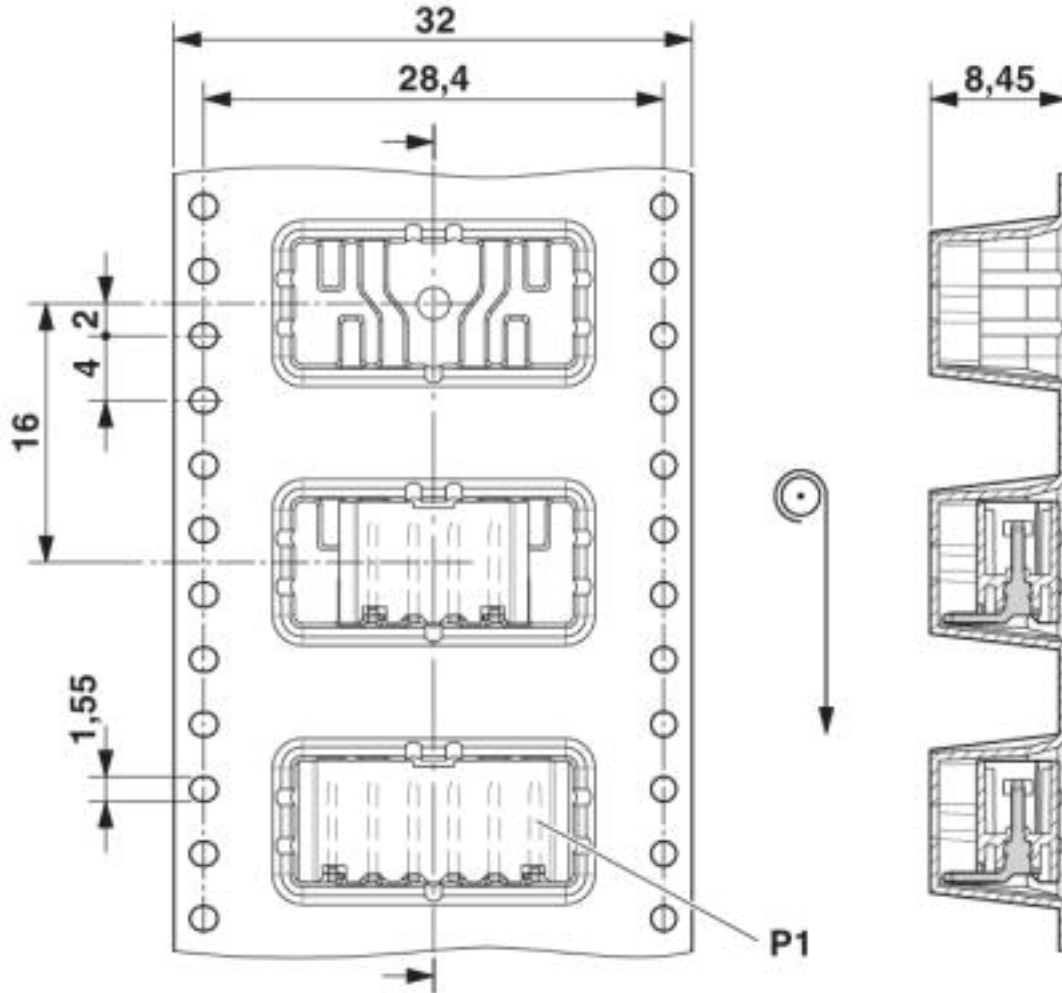

Classifications

eCl@ss

eCl@ss 4.0	27260700
eCl@ss 4.1	27260700
eCl@ss 5.0	27260700
eCl@ss 5.1	27260700
eCl@ss 6.0	27260700
eCl@ss 7.0	27440402
eCl@ss 8.0	27440402
eCl@ss 9.0	27440402

Feed-through header - PTSM 0,5/ 6-HH-2,5-THR R32 - 1778667

Classifications

ETIM

ETIM 3.0	EC001121
ETIM 4.0	EC002637
ETIM 5.0	EC002637
ETIM 6.0	EC002637
ETIM 7.0	EC002637

UNSPSC

UNSPSC 6.01	30211810
UNSPSC 7.0901	39121409
UNSPSC 11	39121409
UNSPSC 12.01	39121409
UNSPSC 13.2	39121409

Approvals

Approvals

Approvals

UL Recognized / VDE Zeichengenehmigung / EAC / cULus Recognized

Ex Approvals

Approval details

UL Recognized		http://database.ul.com/cgi-bin/XYV/template/LISEXT/1FRAME/index.htm	E118976-20130619
		B	
Nominal voltage UN		150 V	
Nominal current IN		5 A	

VDE Zeichengenehmigung		http://www2.vde.com/de/Institut/Online-Service/VDE-gepruefteProdukte/Seiten/Online-Suche.aspx	40048497
Nominal voltage UN		160 V	

Feed-through header - PTSM 0,5/ 6-HH-2,5-THR R32 - 1778667

Approvals

Nominal current IN	6 A
mm ² /AWG/kcmil	0.14-.5

EAC		B.01742
-----	--	---------

cULus Recognized		http://database.ul.com/cgi-bin/XYV/template/LISEXT/1FRAME/index.htm	E60425-20110108
Nominal voltage UN	B		
Nominal current IN	150 V		
	6 A		

Accessories

Additional products

Printed-circuit board connector - PTSM 0,5/ 6-P-2,5 - 1778874



PCB connector, nominal current: 6 A, number of positions: 6, pitch: 2.5 mm, connection method: Push-in spring connection, color: black, contact surface: Tin

Plug - PTPM 0,2/ 6-P-2,5 - 1780493



PCB connector, number of positions: 6, pitch: 2.5 mm, color: black

Plug - PTPM 0,4/ 6-P-2,5 - 1780545



PCB connector, number of positions: 6, pitch: 2.5 mm, color: black

